

Ferrule For SAE 100 R1 EN 853 1SN Hose

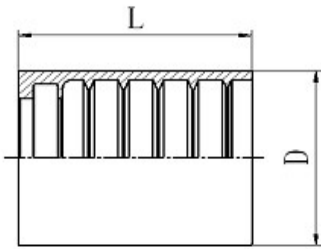

Part.No	L	DN
00110-04	30.5	6
00110-05	30	8
00110-06	32	10
00110-08	34	12
00110-10	37	16
00110-12	42	20
00110-16	51	25
00110-20	59	32
00110-24	74	40
00110-32	78	50

Ferrule For SAE 100 R2AT DIN 20022 2SN Hose

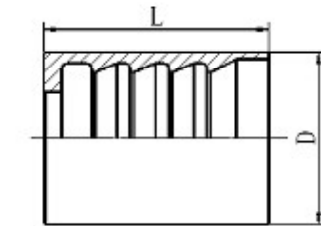

Part.No	L	DN
00210-04	30	6
00210-05	31	8
00210-06	32	10
00210-08	34	12
00210-10	37	16
00210-12	43	20
00210-16	50	25
00210-20	59	32
00210-24	74	40
00210-32	78	50

NOTE: not recommend for engineering machine

Ferrule For DIN/EN 853 1SN/2SN Hose

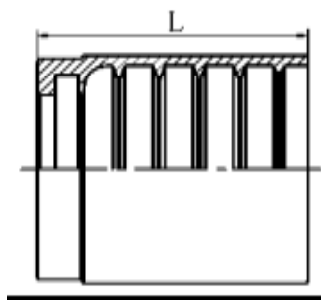

Part.No	L	DN
03310-04	27	6
03310-05	30	8
03310-06	31	10
03310-08	32	12
03310-10	34	16
03310-12	37	20
03310-16	43	25
03310-20	50	32
03310-24	59	38
03310-32	74	50

Ferrule For 4SP, 4SH/12-16, R12/06-16 Hose

Part.No	L	DN
00400-04	37.5	6

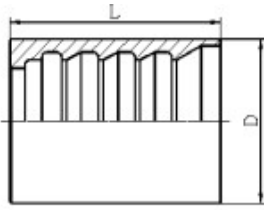

00400-06	39	10
00400-08	41	12
00400-10	43	16
00400-12	51	20
00400-16	61.5	25
00400-20	67.5	32
00400-24	75	40
00400-32	79	50

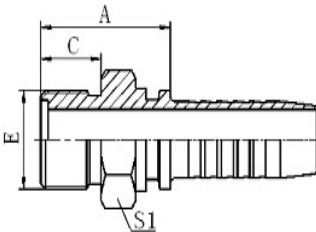

Part.No	Thread E	DN	A	C	S1
10311-12-04	M12×1.25	6	22.5	10	14
10311-14-04	M14×1.5	6	23.5	11	17
10311-16-04	M16×1.5	6	23.5	11	17
10311-16-05	M16×1.5	8	23.5	11	17
10311-16-06	M16×1.5	10	23.5	11	17
10311-18-06	M18×1.5	10	23.5	11	19
10311-22-05	M22×1.5	8	27	12	22
10311-22-06	M22×1.5	10	26	12	22
10311-22-08	M22×1.5	12	26.5	12	22
10311-27-10	M27×1.5	16	31.5	13	27
10311-30-12	M30×1.5	20	33.5	14	32
10311-36-12	M36×2	20	35.5	16	38
10311-36-14	M36×2	22	35.5	16	38
10311-39-16	M39×2	25	39	16	41
10311-45-20	M45×2	32	44.5	20	46
10311-52-24	M52×2	40	47.5	22	55
10311-64-32	M64×2	50	52.5	27	65

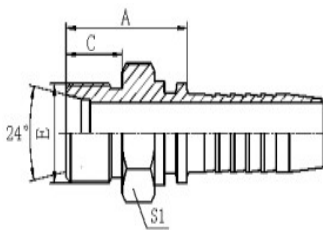

Part.No	Thread E	DN	A	C	S1
10411-12-04	M12×1.5	6	20.5	10	12
10411-14-04	M14×1.5	6	20.5	10	14
10411-14-05	M14×1.5	8	21.5	10	14
10411-16-04	M16×1.5	6	22.5	11	17
10411-16-05	M16×1.5	8	22.5	11	17
10411-16-06	M16×1.5	10	22.5	11	17
10411-18-05	M18×1.5	8	23.5	11	19
10411-18-06	M18×1.5	10	21.5	11	19
10411-22-06	M22×1.5	10	24.5	12	24
10411-22-08	M22×1.5	12	26	12	24
10411-26-08	M26×1.5	12	26.5	12	27
10411-26-10	M26×1.5	16	27	12	27
10411-27-10	M27×1.5	16	32	14	30
10411-30-10	M30×2	16	29	14	32
10411-30-12	M30×2	20	29	14	32
10411-36-16	M36×2	25	31.5	14	38

10411-45-20	M45×2	32	36	16	46
10411-52-24	M52×2	40	38	16	55

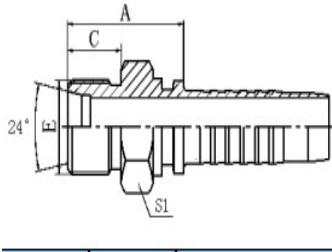

Part. No	Thread E	DN	A	C	S1
10412-14-04	M14×1.5	6	22.5		14
10412-16-05	M16×1.5	8	24		17
10412-18-06	M18×1.5	10	25		19
10412-22-08	M22×1.5	12	26		24
10412-26-10	M26×1.5	16	28		27
10412-30-12	M30×2	20	30.3		32
10412-36-16	M36×2	25	32		41
10412-45-20	M45×2	32	36.5		46
10412-52-24	M52×2	40	38		24

Part. No	Thread E	DN	A	C	S1
10511-14-04	M14×1.5	6	24.1	12	14
10511-16-04	M16×1.5	6	26.5	12	17
10511-18-04	M18×1.5	6	26.5	12	19
10511-20-05	M20×1.5	8	27	12	22
10511-20-06	M20×1.5	10	26.5	12	22
10511-22-05	M22×1.5	8	30.5	14	24
10511-22-06	M22×1.5	19	30.5	14	24
10511-22-08	M22×1.5	12	31	14	24
10511-24-08	M24×1.5	12	31.5	14	27
10511-30-10	M30×2	16	36	16	32
10511-30-12	M30×2	20	36	16	32
10511-36-12	M36×2	20	40.5	18	38
10511-36-16	M36×2	25	41.5	18	38
10511-42-16	M42×2	25	44	20	46
10511-42-20	M42×2	32	45	20	46
10511-52-20	M52×2	32	50	22	55

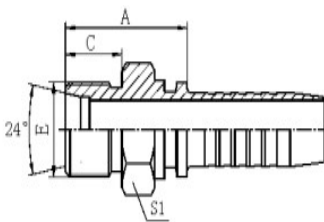

Part. No	Thread E	DN	A	C	S1
10512-16-04	M16×1.5	6	27.5		17
10512-18-04	M18×1.5	6	27.5		19
10512-20-05	M20×1.5	8	30		22
10512-22-06	M22×1.5	10	32		24
10512-24-08	M24×1.5	12	30		27
10512-30-10	M30×1.5	16	37.5		32
10512-36-12	M36×2	20	41.8		38
10512-42-16	M42×2	25	44		46
10512-52-20	M52×2	32	50.5		55

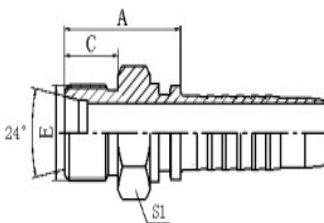

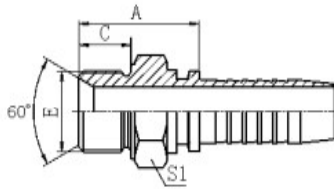

Part. No	Thread E	DN	A	C	S1
10611-14-04	M14×1.5	6	23.5	11	19
10611-14-06	M14×1.5	10	24	11	19
10611-16-04	M16×1.5	6	27.5	12	22
10611-16-05	M16×1.5	8	26.5	12	22
10611-18-06	M16×1.5	10	29.5	12	24
10611-22-06	M18×1.5	10	30.5	14	27
10611-22-08	M22×1.5	12	32	14	27
10611-24-10	M22×1.5	16	35	14	30
10611-26-10	M24×1.5	16	35	16	32
10611-27-10-D	M26×1.5	16	35	16	32
10611-27-10	M27×2	16	37	18	32
10611-30-12-D	M36×1.5	20	38	18	36
10611-30-12	M30×2	20	38	18	36
10611-33-16	M33×2	25	43	20	46
10611-42-20	M42×2	32	46	20	50
10611-45-20	M45×2	32	46	20	55
10611-48-24	M48×2	40	46	20	55
10611-52-24	M52×2	40	46	20	60

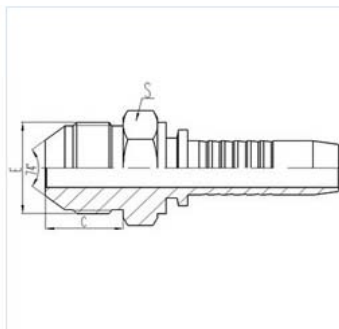

Part. No	Thread E	DN	A	C	S1
10711-10-02	M10×1	4	23	12.5	14
10711-10-03	M10×1	5	23	12.5	14
10711-12-03	M12×1.5	5	26.5	15.7	14
10711-12-03C	M12×1.25	5	24.5	14	14
10711-14-04	M14×1.5	6	30.5	18	17
10711-14-06	M14×1.5	10	30.5	18	17
10711-16-05	M16×1.5	8	31.5	19	17
10711-16-06	M16×1.5	10	31.5	19	17
10711-18-06	M18×1.5	10	31.5	19	19
10711-22-08	M22×1.5	12	35	19.5	22
10711-24-08	M24×1.5	12	37	20	24
10711-27-10	M27×1.5	16	38.5	20.5	27
10711-30-12	M30×1.5	20	42.5	23	32
10711-30-12-E	M30×2	20	45.5	26	32
10711-33-12	M33×2	20	45	26	36
10711-36-14	M36×2	22	45	26	38
10711-39-16	M39×2	25	48	27.5	41
10711-42-20	M42×2	32	52	28.5	46
10711-45-20	M45×2	32	52	28.5	46



Part. No	Thread E	DN	A	C	S1
10811L-12-04	M12×1.5	6	46	34	17
10811L-12-04A	M12×1	6	44.5	32.5	17

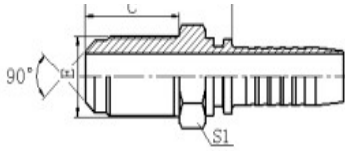

10811L-14-04	M14×1.5	6	46	34	19
10811L-14-06	M14×1.5	10	46.5	34	19
10811L-16-04	M16×1.5	6	46.5	34	22
10811L-16-06	M16×1.5	10	46.5	34	22
10811L-20-06	M20×1.5	10	57	40	27
10811L-20-08	M20×1.5	12	57.5	40	27
10811L-22-08	M22×1.5	12	62.5	45	27

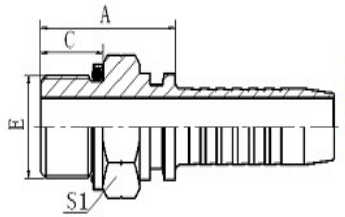

Part. No	Thread E	DN	A	C	S1
12211-04-04	G1/4×19	6	23.5	11	19
12211-04-06	G1/4×19	10	23.5	11	19
12211-06-06	G3/8×19	10	26.5	12	22
12211-08-04	G1/2×14	6	33.5	14	27
12211-08-06	G1/2×14	10	33.5	14	27
12211-08-08	G1/2×14	12	34	14	27
12211-10-10	G5/8×14	16	36	15.5	30
12211-12-10	G3/4×14	16	33.5	15.5	32
12211-12-12	G3/4×14	20	38	15.5	32
12211-12-16	G3/4×14	25	36	15.5	32
12211-16-16	G1×11	25	44.5	18.5	41
12211-20-20	G1.1/4×14	32	46	20	50

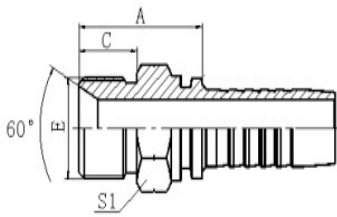

Part. No	Thread E	DN	A	C	S1
12611-02-03	G1/8×28	5	22	10	12
12611-04-04	G1/4×19	6	24.5	12	14
12611-06-05	G3/8×19	8	26	13.5	17
12611-06-06	G3/8×19	10	27.5	13.5	17
12611-06-08	G3/8×14	12	26.5	13.5	19
12611-08-06	G1/2×14	10	30.5	16	22
12611-08-08	G1/2×14	12	31	16	22
12611-10-08	G5/8×14	12	32.5	17.5	24
12611-10-10	G5/8×14	16	33.5	17.5	24
12611-12-08	G3/4×14	12	35.5	18.5	27
12611-12-10	G3/4×14	16	37	18.5	27
12611-12-12	G3/4×14	20	36.5	18.5	27
12611-16-12	G1×11	20	40.5	20.5	36
12611-16-16	G1×11	25	41.5	20.5	36
12611-20-16	G1.1/4×11	25	43.5	20.5	46
12611-20-20	G1.1/4×11	32	44.5	20.5	46
12611-24-20	G1.1/2×11	32	49	23	50
12611-24-24	G1.1/2×11	40	46	23	50
12611-32-32	G2×11	50	53.5	25.5	65

Part. No	Thread E	DN	A	C	S1
----------	----------	----	---	---	----

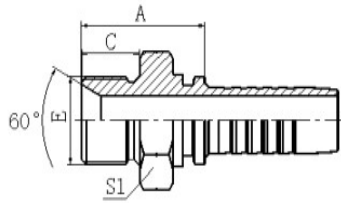

12611A-02-03	G1/8×28	5	22	10	14
12611A-04-04	G1/4×19	6	24.5	12	19
12611A-04-05	G1/4×19	8	24.5	12	19
12611A-06-05	G3/8×19	8	26	13.5	22
12611A-06-06	G3/8×19	10	28	13.5	22
12611A-06-08	G3/8×19	12	28.5	13.5	22
12611A-08-06	G1/2×14	10	33	16	27
12611A-08-08	G1/2×14	12	33.5	16	27
12611A-08-10	G1/2×14	16	32	16	27
12611A-10-08	G5/8×14	12	35	17.5	30
12611A-10-10	G5/8×14	16	36	17.5	30
12611A-12-08	G3/4×14	12	36.5	18.5	32
12611A-12-10	G3/4×14	16	37.5	18.5	32
12611A-12-12	G3/4×14	20	37.5	18.5	32
12611A-16-12	G1×11	20	42.5	20.5	41
12611A-16-16	G1×11	25	43.5	20.5	41
12611A-20-16	G1. 1/4×11	25	45.5	20.5	50
12611A-20-20	G1. 1/4×11	32	46.5	20.5	50
12611A-24-24	G1. 1/2×11	40	49	23	55
12611A-32-32	G1. 1/2×11	50	54.5	25.5	70

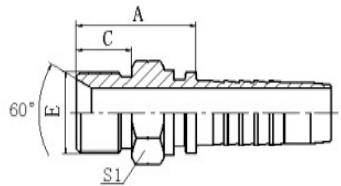

Part. No	Thread E	DN	A	C	S1
12612-04-04	G1/4×19	6	25.5	12	14
12612-06-06	G3/8×19	10	27.5	13.5	17
12612-08-08	G1/2×14	12	32	16	22
12612-10-10	G5/8×14	16	34	17.5	24
12612-12-12	G3/4×14	20	37.8	18.5	27
12611-16-16	G1×11	25	42.5	20.5	36
12612-20-20	G1. 1/4×11	32	45	20.5	46
12612-24-24	G1. 1/2×11	40	49	23	50
12612-32-32	G2×11	50	54.5	25.5	65

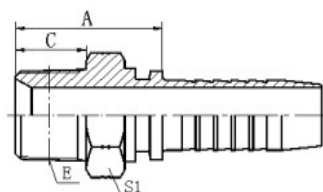

Part. No	Thread E	DN	A	C	S1
13011-02-03SP	R1/8×28	5	22	10	12
13011-02-04SP	R1/8×28	6	22.5	10	12
13011-04-04SP	R1/4×19	6	27	14.5	14
13011-04-05SP	R1/4×19	8	25	15.4	14
13011-04-06SP	R3/8×19	10	27	14.5	17
13011-06-04SP	R3/8×19	6	27.5	15	17
13011-06-05SP	R3/8×19	8	26.5	15	17
13011-06-06SP	R3/8×19	10	27.5	15	17
13011-06-08SP	R1/2×14	12	30	20	19
13011-08-06SP	R1/2×14	10	34.5	20	22
13011-08-08SP	R1/2×14	12	35	20	22
13011-08-10SP	R1/2×14	16	38	20	22

13011-08-12SP	R1/2×14	20	38	20	27
13011-12-08SP	R3/4×14	12	37	20	27
13011-12-10SP	R3/4×14	16	38	20	27
13011-12-12SP	R3/4×14	20	38.5	20	27
13011-12-16SP	R3/4×14	25	39.5	20	32
13011-16-12SP	R1×11	20	44	23.5	36
13011-16-16SP	R1×11	25	45	23.5	36
13011-20-20SP	R1.1/4×11	32	49.5	26.5	46

Part.No	Thread E	DN	A	C	S2
20211-10-02	M10×1	4	14	6	14
20211-12-03	M12×1.25	5	14	8	17
20211-14-04	M14×1.5	6	15.5	8.5	19
20211-14-05	M14×1.5	8	15.5	8.5	19
20211-16-04	M16×1.5	6	16.5	8	22
20211-16-05	M16×1.5	8	16.5	8	22
20211-16-06	M16×1.5	10	16.5	8	22
20211-18-05 T	M18×1.5	8	17.5	8	24
20211-18-06	M18×1.5	10	17.5	8	24
20211-20-06-T	M20×1.5	10	16	10	24
20211-20-08	M20×1.5	12	18.5	10	27
20211-22-06-T	M22×1.5	10	16	10	27
20211-22-08	M22×1.5	12	18.5	10	27
20211-22-10	M22×1.5	16	19.5	10	27
20211-24-08-T	M24×1.5	12	16.5	11	30
20211-24-10	M24×1.5	16	20.5	10.5	30
20211-27-08-T	M27×1.5	12	18.5	10	32
20211-27-10-T	M27×1.5	16	19.5	10	32
20211-30-12	M30×1.5	20	21.5	11	36
20211-33-14	M33×2	22	21.5	13	41

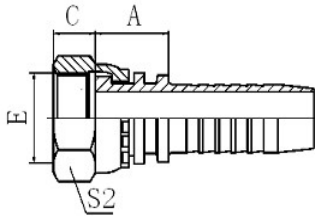

Part.No	Thread E	DN	A	C	S2
20241-14-04	M14×1.5	6	40.5	8.5	19
20241-14-05	M14×1.5	8	42.7	8.5	19
20241-16-05	M16×1.5	8	44.4	8.5	22
20241-18-06	M18×1.5	10	45.7	8	24
20241-22-08	M22×1.5	12	58.9	10	27
20241-27-10-T	M27×1.5	16	71.2	10	32
20241-30-12	M30×1.5	20	78.1	11	36
20241-36-12-T	M36×2	20	75	13	41
20241-36-14-T	M36×2	22	77.3	13	41
20241-36-16	M36×2	25	85.7	13	41
20241-39-16-T	M39×2	25	83.9	13	46
20241-42-20	M42×2	32	97.3	15	50
20241-45-20-T	M45×2	32	94.5	15	55

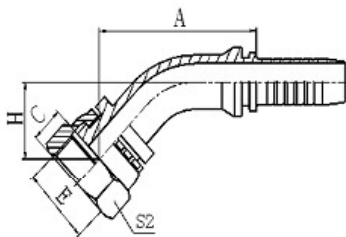

20241-52-20-T	M52×2	32	94.5	17	60
20241-52-24-T	M52×2	40	109	17	60

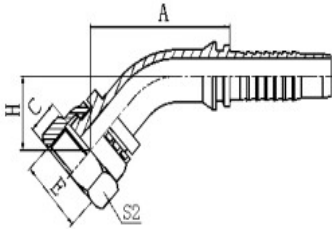

Part. No	Thread E	DN	A	H	S2
20242-16-04	M16×1.5	6	42.3	19.2	22
20242-18-06	M18×1.5	10	47.2	21.4	24
20242-22-08	M22×1.5	12	59.9	24	27
20242-27-10	M27×1.5	16	71.7	26.4	32
20242-30-12	M30×1.5	20	79.4	30	36
20242-36-14-T	M36×2	22	79.3	27	41
20242-39-16-T	M39×2	25	86.2	29.7	46
20242-45-20-T	M45×2	32	96.5	33.8	55
20242-52-24-T	M52×2	40	109	37.7	60
20242-64-32-T	M64×2	50	129	45.6	75

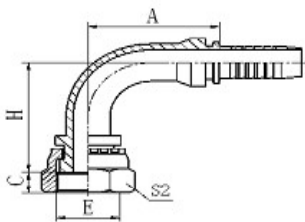

Part. No	Thread E	DN	A	C	H	S2
20291-12-02	M12×1.25	4	26.5	8	30.5	17
20291-12-04	M12×1.25	6	30	8	33.5	17
20291-14-04	M14×1.5	6	30	8.5	34	19
20291-14-05	M14×1.5	8	33	8.5	37	19
20291-16-04	M16×1.5	6	30	8	35	22
20291-16-05	M16×1.5	8	34	8	38	22
20291-16-06	M16×1.5	10	35.3	8	40.3	22
20291-18-05-T	M18×1.5	8	33	8	39	24
20291-18-06	M18×1.5	10	35.8	8	41.3	24
20291-22-08	M22×1.5	12	41	10	48	27
20291-22-10	M22×1.5	16	57.5	10	53	27
20291-24-08-T	M24×1.5	12	41	11	45.5	30
20291-27-04-T	M27×1.5	6	30	10	35.5	32
20291-27-08-T	M27×1.5	12	41	10	46	32
20291-27-10-T	M27×1.5	16	56	10	51	32
20291-30-12	M30×1.5	20	66.2	11	63.5	36
20291-33-14	M33×2	22	71.2	13	65	41
20291-36-14-T	M36×2	22	71.2	13	61	41
20291-36-16	M36×2	25	76.7	13	70	41
20291-39-16-T	M39×2	25	76.7	13	67.5	46

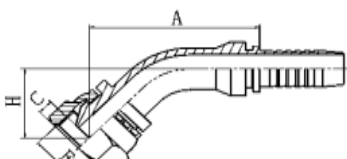

Part. No	Thread E	DN	A	C	H	S2
20641-14-04	M14×1.5	6	42.7	5.5	20.6	19
20641-16-05	M16×1.5	8	45.1	5.5	21.8	22
20641-18-06	M18×1.5	10	47.4	5.5	23.2	24
20641-22-08	M22×1.5	12	61.8	6	26.8	27
20641-27-10-DT	M27×1.5	16	71.4	6	27.1	32



20641-30-12-D	M30×1.5	20	81.6	6	33.5	36
20641-36-14-T	M36×2	22	81.9	6.5	31.6	41
20641-39-16-T	M39×2	25	88.5	6.5	34.3	46
20641-45-20-T	M45×2	32	99.1	8.5	38.4	55
20641-52-24-T	M52×2	40	113	10	42.7	60

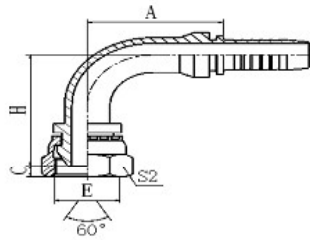

Part. No	Thread E	DN	A	C	H	S2
20691-14-04	M14×1.5	6	30	5.5	37	19
20691-16-05	M16×1.5	8	33	5.5	40.5	22
20691-18-06	M18×1.5	10	35.3	5.5	43.8	24
20691-22-08	M22×1.5	12	41	6	52	27
20691-27-10-DT	M27×1.5	16	56.5	6	58	32
20691-30-12-D	M30×1.5	20	66.2	6	68.5	36
20691-36-14-T	M36×2	25	78	6.5	76.5	41
20691-36-16	M39×2	22	71.2	6.5	67.5	41
20691-39-16-T	M39×2	25	76.7	6.5	74	46
20691-45-20-T	M45×2	32	91.5	8.5	85	55
20691-52-24-T	M52×2	40	109	10	99	60

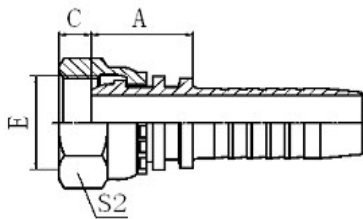

Part. No	Thread E	DN	A	C	S2
20111-10-03	M10×1	5	18	2.5	14
20111-10-04	M10×1	6	18	2.5	14
20111-12-04	M12×1.5	6	18.5	4	17
20111-12-05	M12×1.5	8	18.5	4	17
20111-14-04	M14×1.5	6	19.5	4.5	19
20111-14-05	M14×1.5	8	19.5	4.5	19
20111-16-04	M16×1.5	6	19.5	4.5	22
20111-16-05	M16×1.5	8	20	4.5	22
20111-16-06	M16×1.5	10	20	4.5	22
20111-18-05-T	M18×1.5	8	21.5	4	24
20111-18-06	M18×1.5	10	21.5	4	24
20111-18-08	M18×1.5	12	22	4	24
20111-20-06-T	M20×1.5	10	20.5	5.5	24
20111-20-08	M20×1.5	12	23	5.5	27
20111-22-06-T	M22×1.5	10	23	5	27
20111-22-08	M22×1.5	12	23.5	5	27
20111-22-10	M22×1.5	16	24.5	5	27
20111-24-08-T	M24×1.5	12	22	5.5	30
20111-24-10	M24×1.5	16	26	5	30
20111-27-08-DT	M27×1.5	12	23	5.5	32
20111-30-12-D	M30×1.5	20	26.5	6	36
20111-30-12	M30×2	20	26.5	7	36
20111-36-14-T	M36×2	22	26	7	41
20111-39-16-T	M39×2	25	28.5	7	46
20111-45-20-T	M45×2	32	31.5	8.5	55

20111-52-24-T	M52×2	40	33	9	60
---------------	-------	----	----	---	----

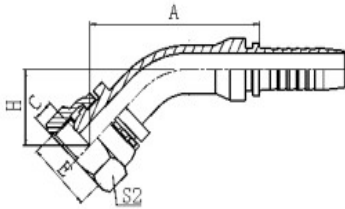

Part. No	Thread E	DN	A	C	H
20141-10-03	M10×1	5	41.1	2.5	20.7
20141-10-04	M10×1	6	43.2	2.5	21.5
20141-12-03	M12×1.25	5	40.9	4	21.2
20141-12-04	M12×1.25	6	43	4	22
20141-14-04	M14×1.5	6	43.4	4.5	21.3
20141-14-05	M14×1.5	8	45.5	4.5	22.2
20141-16-04	M16×1.5	6	43.7	4.5	21.4
20141-16-05	M16×1.5	8	45.8	4.5	22.5
20141-16-06	M16×1.5	10	47.4	4.5	24.1
20141-18-05-T	M18×1.5	8	46.8	4	22.6
20141-18-06	M18×1.5	10	48.5	4	24.2
20141-18-08	M18×1.5	12	52.2	4	25.7
20141-20-06-T	M20×1.5	10	48.2	5.5	23.9
20141-20-08	M20×1.5	12	62.1	5.5	27.2
20141-22-06-T	M22×1.5	10	58.4	5	25.7
20141-22-08	M22×1.5	12	62.1	5	27.2
20141-24-08-T	M24×1.5	12	61.1	5.5	26.1
20141-24-10	M24×1.5	16	75.4	5	29.6
20141-27-10-DT	M27×1.5	16	74.4	5.5	29.6
20141-27-10-T	M27×2	16	74.4	5.5	29.6
20141-30-12-D	M30×1.5	20	80.9	6	33.5
20141-30-12	M30×2	20	80.9	6	33.5
20141-36-14-T	M36×2	22	83	7	32.6
20141-39-16-T	M39×2	25	88.2	7	34
20141-45-20-T	M45×2	32	99.1	8.5	38.4
20141-52-24-T	M52×2	40	114	9	43.4

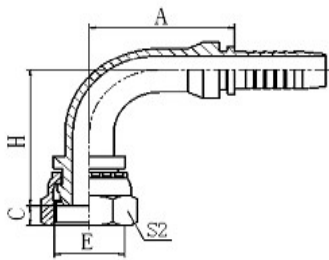

Part. No	Thread E	DN	A	C	H
20191-10-03	M10×1	5	27	2.5	35.5
20191-12-04	M12×1.25	6	30	4	37.5
20191-14-04	M14×1.5	6	30	4.5	38
20191-14-05	M14×1.5	8	33	4.5	41
20191-16-04	M16×1.5	6	30	4.5	38.5
20191-16-05	M16×1.5	8	33	4.5	41.5
20191-16-06	M16×1.5	10	35.3	4.5	43.8
20191-18-05-T	M18×1.5	8	33	4	43
20191-18-06	M18×1.5	10	35.5	4	45.3
20191-18-08	M18×1.5	12	40.5	4	50.5
20191-20-06-T	M20×1.5	10	35.3	5.5	44.8
20191-20-08	M20×1.5	12	41	5.5	52
20191-22-06-T	M22×1.5	10	35.8	5	76.8
20191-22-08	M22×1.5	12	41	5	52.5

20191-24-08-T	M24×1.5	12	41	5.5	51
20191-24-10	M24×1.5	16	58	5	58.5
20191-27-10-DT	M27×1.5	16	56	5.5	55.5
20191-27-10-T	M27×2	16	56	5.5	55.5
20191-30-12-D	M30×1.5	20	67.5	6	68.5
20191-30-12	M30×2	20	67.5	6	68.5
20191-36-12-T	M36×2	20	65.5	7	68
20191-36-14-T	M36×2	22	71.2	7	69
20191-39-16-T	M39×2	25	76.7	7	73.5
20191-45-20-T	M45×2	32	91.5	8.5	85
20191-52-24-T	M52×2	40	109	9	100
20191-64-32-T	M64×2	50	132	14	122

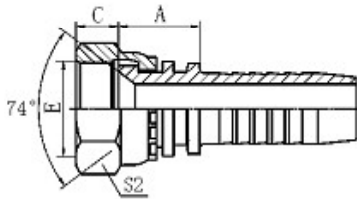

Part. No	Thread E	DN	A	C	S2
20711-14-04	M14×1.5	6	15.5	8.5	19
20711-14-05	M14×1.5	8	15.5	8.5	19
20711-14-06	M14×1.5	10	15.5	8.5	19
20711-16-04	M16×1.5	6	16.5	8	22
20711-16-05	M16×1.5	8	16.5	8	22
20711-16-06	M16×1.5	10	16	8	22
20711-18-05-T	M18×1.5	8	16	8	22
20711-18-06	M18×1.5	10	17.5	10	24
20711-20-06-T	M20×1.5	10	16	10	24
20711-20-08	M20×1.5	12	18.5	10	27
20711-22-06-T	M22×1.5	10	16	10	27
20711-22-08	M22×1.5	12	18.5	10	27
20711-22-10	M22×1.5	16	19.5	10	27
20711-24-08-T	M24×1.5	12	16.5	11	30
20711-27-08-T	M27×1.5	12	18.5	11	32
20711-27-10-T	M27×1.5	16	19.5	11	32
20711-27-12	M27×1.5	20	21.5	11	32
20711-30-10-T	M30×1.5	16	18.5	11	36
20711-30-12	M30×1.5	20	21.5	11	36
20711-33-10-T	M33×2	16	20	13	41
20711-33-12-T	M33×2	20	20	13	41
20711-33-14-T	M33×2	22	21.5	13	41
20711-36-12-T	M36×2	20	20	14	41
20711-36-14-T	M36×2	22	20	14	41
20711-36-16	M36×2	25	23	14	41
20711-39-16-T	M39×2	25	23.5	14	46
20711-42-16-T	M42×2	25	23.5	15	50
20711-42-20	M42×2	32	26	15	50
20711-45-20-T	M45×2	32	25	15	55
20711-52-24-T	M52×2	40	25	17	60

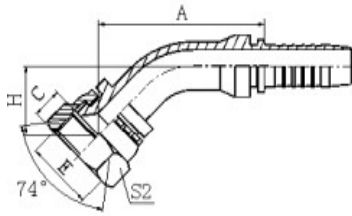

Part. No	Thread E	DN	A	C	H	S2
20741-14-04	M14×1.5	6	40.5	8.5	18.5	19
20741-16-05	M16×1.5	8	44.4	8	20	22
20741-18-06	M18×1.5	10	45.7	10	21.4	24
20741-22-08	M22×1.5	12	58.9	10	24	27
20741-27-10	M27×1.5	16	71.2	11	26.4	32
20741-30-12	M30×1.5	20	78.1	11	30	36
20741-33-12	M33×2	20	77.4	13	30	41
20741-33-16	M33×2	25	85	13	30.8	41
20741-36-14	M36×2	22	79.8	14	29.6	41
20741-36-16	M36×2	25	85.7	14	31.5	41
20741-39-16	M39×2	25	86.1	14	31.8	46
20741-45-20-W	M45×2	32	97	15	36.2	55
20741-52-24-W	M52×2	40	113	17	40.9	60

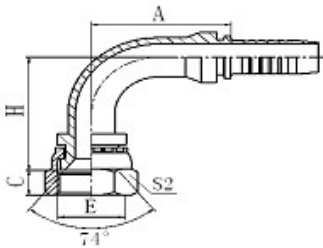

Part. No	Thread E	DN	A	C	H	S2
20791-12-04-C	M12×1.25	6	30	9	33.5	17
20791-12-04	M12×1.5	6	30	10	33.5	17
20791-14-05	M14×1.5	6	30	8.5	34	19
20791-16-04	M16×1.5	6	30	8	35	22
20791-16-05	M16×1.5	8	34	8	38	22
20791-18-06	M18×1.5	10	35.3	10	41.3	24
20791-22-08	M22×1.5	12	41	10	48	27
20791-22-10	M22×1.5	16	56.5	10	52.5	27
20791-27-10	M27×1.5	16	56.5	11	54	32
20791-30-12	M30×1.5	20	66.2	11	63.5	36
20791-33-12	M33×2	20	66	13	63.5	41
20791-33-16	M33×2	25	76.7	13	69	41
20791-36-12	M36×2	20	65.5	14	63.5	41
20791-36-14	M36×2	22	71.2	14	64.5	41
20791-39-16	M39×2	25	76.7	14	70.5	46
20791-45-20-W	M45×2	32	91.5	15	83	55
20791-52-20-W	M52×2	32	93	17	84.5	60
20791-52-24-W	M52×2	40	111	17	96.5	60

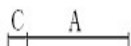

Part. No	Thread E	DN	A	C	S2	o ring
20411-12-04	M12×1.5	6	26	1	17	o 04.5×1.5
20411-14-04	M14×1.5	6	27.5	2	19	o 06.5×1.5
20411-14-06	M14×1.5	10	27.5	2	19	o 06.5×1.5
20411-16-04	M16×1.5	6	28	2	22	o 08.0×1.5
20411-16-05	M16×1.5	8	28	2	22	o 08.0×1.5
20411-16-06	M16×1.5	10	28	2	22	o 08.0×1.5
20411-18-05-T	M18×1.5	8	27.5	1.8	22	o 10.0×1.5

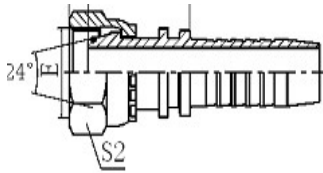

20411-18-06	M18×1.5	10	29	2.5	24	o 10.0×1.5
20411-18-08	M18×1.5	12	29.5	2.5	24	o 10.0×1.5
20411-22-05-T	M22×1.5	8	29.5	2.1	27	o 12.0×2.0
20411-22-06-T	M22×1.5	10	29	2.5	27	o 12.0×2
20411-22-08	M22×1.5	12	32	2.5	27	o 12.0×2
20411-26-10	M26×1.5	16	35	2.5	32	o 15.0×2
20411-26-12	M26×1.5	20	35	2.5	32	o 15.0×2
20411-27-10-T	M27×1.5	16	28	2.5	32	o 15.0×2
20411-27-12	M27×1.5	20	35	2.5	32	o 15.0×2
20411-30-10-T	M30×2	16	35	4	36	o 20.0×2
20411-30-12	M30×2	20	38	4	36	o 20.0×2
20411-36-12-T	M36×2	20	35	4	41	o 26.0×2
20411-36-14-T	M36×2	22	36	4	41	o 26.0×2
20411-45-16-T	M45×2	25	41	5	55	o 32.0×2
20411-45-20-T	M45×2	32	42	5	55	o 32.0×2
20411-52-20-T	M52×2	32	44	5.5	60	o 38.0×2
20411-52-24-T	M52×2	40	44	5.5	60	o 38.0×2

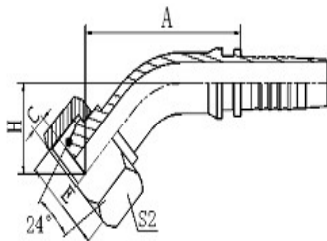

Part.No	Thread E	DN	A	C	S2	o ring
20441-14-04	M14×1.5	6	49	2	19	o 06.5×1.5
20441-16-05	M16×1.5	8	51.5	2	22	o 08.0×1.5
20441-16-06	M16×1.5	10	53.4	2	22	o 08.0×1.5
20441-18-05-T	M18×1.5	8	46.2	2.5	22	o 10.0×1.5
20441-18-06	M18×1.5	10	54.2	2.5	24	o 10.0×1.5
20441-22-05-T	M22×1.5	8	48.3	2.5	27	o 12.0×2.0
20441-22-06-T	M22×1.5	10	50.4	2.5	27	o 12.0×2
20441-22-08	M22×1.5	12	68.1	2.5	27	o 12.0×2
20441-26-08-T	M26×1.5	12	62	2.5	32	o 15.0×2
20441-26-10	M26×1.5	16	80.7	2.5	32	o 15.0×2
20441-26-12	M26×1.5	20	86.9	2.5	32	o 15.0×2
20441-27-10-T	M27×1.5	16	72	2.5	32	o 15.0×2
20441-27-12	M27×1.5	20	86.9	2.5	32	o 15.0×2
20441-30-10-T	M30×2	16	75.1	4	36	o 20.0×2
20441-30-12	M30×2	20	89.1	4	36	o 20.0×2
20441-36-12-T	M36×2	20	82	4	41	o 26.0×2
20441-36-14-T	M36×2	22	83.7	4	41	o 26.0×2
20441-45-20-T	M45×2	32	99.6	5	55	o 32.0×2
20441-52-20-T	M52×2	32	103	5.5	60	o 38.0×2
20441-52-24-T	M52×2	40	117	5.5	60	o 38.0×2

Part.No	Thread E	DN	A	C	H	o ring
20491-12-03	M12×1.5	5	26.5	1	41.5	o 04.5×1.5
20491-12-04	M12×1.5	6	30	1	44.5	o 04.5×1.5
20491-14-04	M14×1.5	6	30	2	46	o 06.5×1.5
20491-16-04	M16×1.5	6	30	2	46.5	o 08.0×1.5



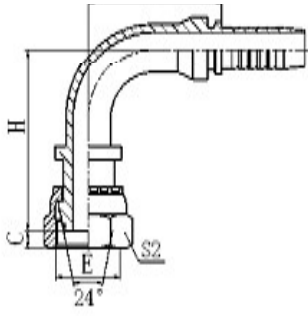

20491-16-05	M16×1.5	8	33	2	49.5	o 08.0×1.5
20491-16-06	M16×1.5	10	35.3	2	51.8	o 08.0×1.5
20491-18-05-T	M18×1.5	8	33	2.5	42	o 10.0×1.5
20491-18-06	M18×1.5	10	35.3	2.5	53.3	o 10.0×1.5
20491-22-06-T	M22×1.5	10	35.3	2.5	47.3	o 12.0×2.0
20491-22-08	M22×1.5	12	41	2.5	61	o 12.0×2
20491-26-08-T	M26×1.5	12	42	2.5	51	o 15.0×2
20491-26-10	M26×1.5	16	56.5	2.5	67.5	o 15.0×2
20491-26-12	M26×1.5	20	65.5	2.5	77	o 15.0×2
20491-27-10-T	M27×1.5	16	56.5	2.5	67.5	o 15.0×2
20491-27-12	M27×1.5	20	65.5	2.5	77	o 15.0×2
20491-30-10-T	M30×2	16	56.5	4	57.2	o 20.0×2
20491-30-12	M30×2	20	65.5	4	80	o 20.0×2
20491-36-12-T	M36×2	20	65.5	4	69	o 26.0×2
20491-36-14-T	M36×2	22	71.2	4	70	o 26.0×2
20491-45-16-T	M45×2	25	76.7	5	75	o 32.0×2
20491-45-20-T	M45×2	32	91.5	5	88.5	o 32.0×2
20491-52-20-T	M52×2	32	93	5.5	87	o 38.0×2
20491-52-24-T	M52×2	40	109	5.5	104	o 38.0×2

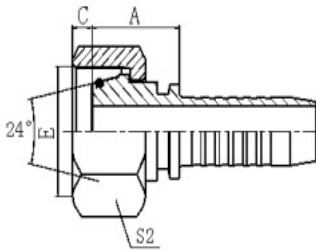

Part.No	Thread E	DN	A	C	S2	o ring
20511-14-04	M16×1.5	6	28.5	1.1	19	o 04.5×1.5
20511-16-04	M16×1.5	6	29	1.5	22	o 06.5×1.5
20511-16-05	M16×1.5	8	29	1.5	22	o 06.5×1.5
20511-18-04-T	M18×1.5	6	26.5	2	22	o 08.0×1.5
20511-18-06	M18×1.5	10	29	2	24	o 08.0×1.5
20511-20-06-T	M20×1.5	10	28.5	2.5	24	o 10.0×1.5
20511-20-08	M20×1.5	12	31.5	2.5	27	o 10.0×1.5
20511-22-06-T	M22×1.5	10	28.5	2.5	27	o 11.0×2
20511-22-08	M22×1.5	12	31.5	2.5	27	o 11.0×2
20511-24-06-T	M24×1.5	10	28.5	2.5	30	o 13.0×2
20511-24-08-T	M24×1.5	12	30	3	30	o 13.0×2
20511-30-10-T	M30×2	16	36	3	36	o 16.3×2.4
20511-30-12	M30×2	20	39	3	36	o 16.3×2.4
20511-36-12-T	M36×2	20	36	3	41	o 20.3×2.4
20511-36-14-T	M36×2	22	36	3	41	o 20.3×2.4
20511-42-12-T	M42×2	20	40	5	50	o 25.3×2.4
20511-42-16-T	M42×2	25	41	5	50	o 25.3×2.4
20511-52-20-T	M52×2	32	44	6.5	60	o 33.3×2.4
20511-52-24-T	M52×2	40	44	6.5	60	o 33.3×2.4

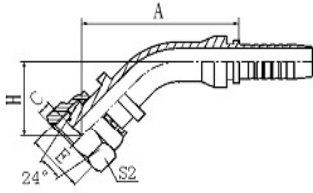

Part. No	Thread E	DN	A	C	S2	o ring
20541-14-04	M14×1.5	6	50.1	1.1	19	o 04.5×1.5
20541-16-04	M16×1.5	6	50.4	1.5	22	o 06.5×1.5
20541-16-05	M16×1.5	8	52.2	1.5	22	o 06.5×1.5
20541-18-04-T	M18×1.5	6	43.4	2	22	o 08.0×1.5
20541-18-06	M18×1.5	10	54.3	2	24	o 08.0×1.5
20541-20-06-T	M20×1.5	10	49.7	2.5	24	o 10.0×1.5
20541-20-08	M20×1.5	12	67.8	2.5	27	o 10.0×1.5
20541-22-06-T	M22×1.5	10	49.6	2.5	27	o 11.0×2
20541-22-08	M22×1.5	12	68.1	2.5	27	o 11.0×2
20541-24-08-T	M24×1.5	12	62.5	3	30	o 13.0×2
20541-24-10-T	M24×1.5	16	80.7	2.5	30	o 13.0×2
20541-30-10-T	M30×2	16	75.8	3	36	o 16.3×2.4
20541-30-12	M30×2	20	90.5	3	36	o 16.3×2.4
20541-36-12-T	M36×2	20	82.7	3	41	o 20.3×2.4
20541-36-14-T	M36×2	22	84.4	3	41	o 20.3×2.4
20541-42-16-T	M42×2	25	92.3	5	50	o 25.3×2.4
20541-52-20-T	M52×2	32	103	6.5	60	o 33.3×2.4
20541-52-24-T	M52×2	40	116	6.5	60	o 33.3×2.4

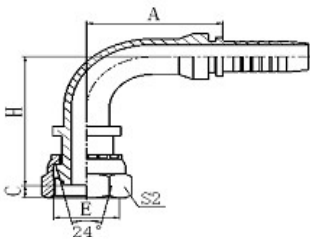

Part. No	Thread E	DN	A	C	H	o ring
20591-14-04	M14×1.5	6	30	1.1	47.5	o 04.5×1.5
20591-16-04	M16×1.5	6	30	1.5	48	o 06.0×1.5
20591-16-05	M16×1.5	8	33	1.5	51	o 06.0×1.5
20591-18-05-T	M18×1.5	8	33	2	41.5	o 08.0×1.5
20591-18-06	M18×1.5	10	35.3	2	52.8	o 08.0×1.5
20591-20-06-T	M20×1.5	10	35.8	2.5	46.3	o 1.0×1.5
20591-20-08	M20×1.5	12	41	2.5	61	o 1.0×1.5
20591-22-06-T	M22×1.5	10	35.3	2.5	46.8	o 11.0×2
20591-22-08	M22×1.5	12	41	2.5	61	o 11.0×2
20591-24-08-T	M24×1.5	12	41	3	53	o 13.0×2
20591-24-10	M24×1.5	16	56.5	2.5	67.5	o 13.0×2
20591-30-10-T	M30×2	16	56.5	3	60.5	o16.3.0×2.4
20591-30-12	M30×2	20	65.5	3	81	o16.3.0×2.4
20591-36-12-T	M36×2	20	66.2	3	70	o20.3.0×2.4
20591-36-14-T	M36×2	22	71.2	3	71	o20.3.0×2.4
20591-42-16-T	M42×2	25	78	5	77.5	o25.3.0×2.4
20591-52-20-T	M52×2	32	93	6.5	89	o33.3.0×2.4
20591-52-24-T	M52×2	40	109	6.5	103	o33.3.0×2.4

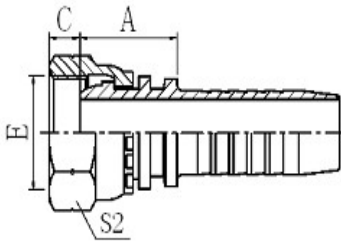

Part. No	Thread E	DN	A	C	S1
22211-02-04	G1/8×28	6	19	2	14
22211-04-03	G1/4×19	5	19	4	19
22211-04-04	G1/4×19	6	19.5	4	19
22211-06-05	G3/8×19	8	20	5	22
22211-06-06	G3/8×19	10	20.5	5	22
22211-06-08	G3/8×19	12	21	5	22
22211-08-06-T	G1/2×14	10	22.5	6	27
22211-08-08	G1/2×14	12	23	6	27
22211-08-10	G1/2×14	16	24	6	27
22211-10-10	G5/8×14	16	25	8	30
22211-10-12	G5/8×14	20	25	8	30
22211-12-08-T	G3/4×14	12	25	9.5	32
22211-12-10	G3/4×14	16	26	9.5	32
22211-12-12	G3/4×14	20	26	9.5	32
22211-16-12-T	G1×11	20	26.5	11	41
22211-16-14	G1×11	22	26.5	11	41
22211-16-16	G1×11	25	28	11	41
22211-20-16-T	G1. 1/4×11	25	27.5	11	50
22211-20-20-W	G1. 1/4×11	32	31.5	10	50
22211-24-24-W	G1. 1/2×11	40	37	11.5	55
22211-32-32-W	G2×11	50	34	15	70

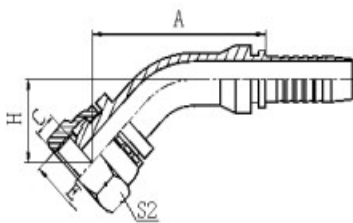

Part. No	Thread E	DN	A	C	S1	H
22141-02-04	G1/8×28	6	43.7	2	14	21.6
22141-04-03	G1/4×19	5	41.3	4	19	20.4
22141-04-04	G1/4×19	6	43.7	4	19	21.6
22141-06-05	G3/8×19	8	46.2	5	22	22.9
22141-06-06	G3/8×19	10	48.1	5	22	23.9
22141-06-08	G3/8×19	12	60.4	5	22	25.4
22141-08-04-T	G1/2×14	6	43.9	6	27	23.8
22141-08-06-T	G1/2×14	10	42.5	6	27	18.2
22141-08-08	G1/2×14	12	61.8	6	27	26.8
22141-08-10	G1/2×14	16	73	6	27	29
22141-10-10	G5/8×14	16	73.7	8	30	28.9
22141-10-12	G5/8×14	20	79.8	8	30	32.5
22141-12-08-T	G3/4×14	12	63.2	9.5	32	28.3
22141-12-10	G3/4×14	16	70.4	9.5	32	29.6
22141-12-12	G3/4×14	20	80.6	9.5	32	33.2
22141-16-12	G1×11	20	81.6	11	41	33.5
22141-16-14	G1×11	22	83.3	11	41	33
22141-16-16	G1×11	25	89.2	11	41	35
22141-20-16-T	G1. 1/4×11	25	91.4	9.1	50	37.1
22141-20-20-W	G1. 1/4×11	32	103	10	50	41.2

22141-24-24-W	G1. 1/2×11	40	120	11.5	55	49
22141-32-32-W	G2×11	50	137	15	70	53

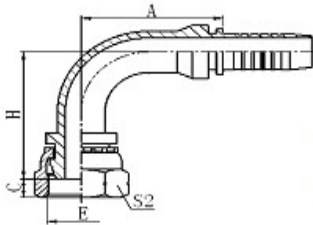

Part. No	Thread E	DN	A	C	H	S1
22191-02-04	G1/8×28	6	30	2	38.5	14
22191-04-03	G1/4×19	5	27	4	35	19
22191-04-04	G1/4×19	6	30	4	38.5	19
22191-04-05	G1/4×19	8	33	4	41.5	22
22191-06-05	G3/8×19	8	33	5	42	22
22191-06-06	G3/8×19	10	35.3	5	44.8	22
22191-06-08	G3/8×19	12	41	5	50	27
22191-08-06-T	G1/2×14	10	35.3	6	46.8	27
22191-08-08	G1/2×14	12	41	6	52	27
22191-08-10	G1/2×14	16	56.5	6	58	27
22191-10-10	G5/8×14	16	56.5	8	57.5	30
22191-10-12	G5/8×14	20	65.4	8	67	30
22191-12-08-T	G3/4×14	12	41	9.5	52	32
22191-12-10	G3/4×14	16	56.5	9.5	58.5	32
22191-12-12	G3/4×14	20	65.5	9.5	68	32
22191-16-12-T	G1×11	20	66.2	11	68.5	41
22191-16-14	G1×11	22	71.2	11	69.5	41
22191-16-16	G1×11	25	76.7	11	75	41
22191-20-16-T	G1. 1/4×11	25	76.7	9.1	78	50
22191-20-20-W	G1. 1/4×11	32	92.3	10	85.3	50
22191-24-24-W	G1. 1/2×11	40	109	11.5	108	55
22191-32-32-W	G2×11	50	133	15	124	70

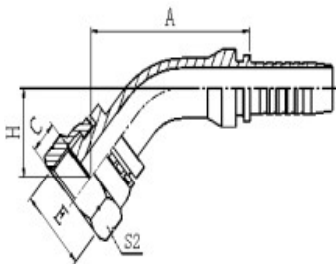

Part. No	Thread E	DN	A	C	S1	H
22241-04-04	G1/4×19	6	40.9	8	19	18.8
22241-06-06	G3/8×19	10	45.3	9	22	21
22241-08-08	G1/2×14	12	58.9	10.5	27	24
22241-12-12	G3/4×14	20	77.4	13.5	32	30
22241-16-16	G1×11	25	82.7	15.5	41	31.5
22241-20-20-W	G1. 1/4×11	32	97.3	15.5	50	36.6

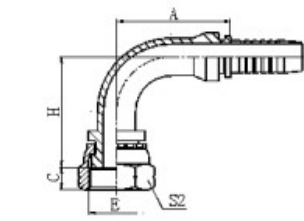

Part. No	Thread E	DN	A	C	S1	H
22291-04-04	G1/4×19	6	30	8	19	34.5
22291-06-06	G3/8×19	10	35.3	9	22	41.3
22291-08-08	G1/2×14	12	41	10.5	27	48
22291-12-12	G3/4×14	20	65.5	13.5	32	63.5
22291-16-16	G1×11	25	76.7	15.5	41	70
22291-20-20-W	G1. 1/4×11	32	91.5	15.5	50	82.5

22291-24-24-W	G1. 1/2×11	40	109	17.5	55	98.5
---------------	------------	----	-----	------	----	------

Part. No	Thread E	DN	A	C	S1
22611-02-03	G1/8×28	5	15	5.5	14
22611-02-04	G1/8×28	6	15	5.5	14
22611-04-03	G1/4×19	5	17	5.5	19
22611-04-04	G1/4×19	6	18	5.5	19
22611-04-05	G1/4×19	8	18	5.5	19
22611-04-06	G1/4×19	10	18	5.5	19
22611-06-04	G3/8×19	6	19	6.3	22
22611-06-05	G3/8×19	8	19	6.3	22
22611-06-06	G3/8×19	10	19.5	6.3	22
22611-06-08	G3/8×19	12	19.5	6.3	22
22611-08-06-T	G1/2×14	10	21	7.5	27
22611-08-08	G1/2×14	12	21.5	7.5	27
22611-10-08	G5/8×14	12	22	9.5	30
22611-10-10	G5/8×14	16	23.5	9.5	30
22611-12-08-T	G3/4×14	12	22	10.9	32
22611-12-10	G3/4×14	16	24	10.9	32
22611-12-12	G3/4×14	20	24	9.5	32
22611-16-12-T	G1×11	20	24	11.7	41
22611-16-14	G1×11	22	26	11.7	41
22611-16-16	G1×11	25	27	11.7	41
22611-20-16-T	G1. 1/4×11	25	27.5	11	50
22611-20-20-W	G1. 1/4×11	32	30.5	11	50
22611-24-20-W	G1. 1/2×11	32	32	13	55
22611-24-24-W	G1. 1/2×11	40	32	13	55
22611-32-24-W	G2×11	40	30	16	70
22611-32-32-W	G2×11	50	31.9	16	70

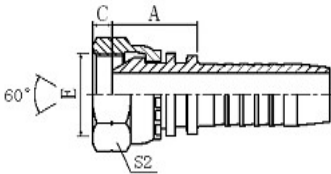

Part. No	Thread E	DN	A	S2
22612-04-04	G1/4×19	6	18	19
22612-06-06	G3/8×19	10	21	22
22612-08-08	G1/2×14	12	22.5	27
22612-10-10	G5/8×14	16	24	30
22612-12-12	G3/4×14	20	25.3	32

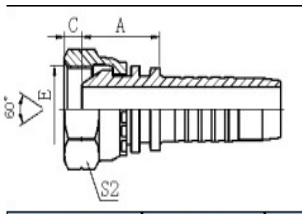

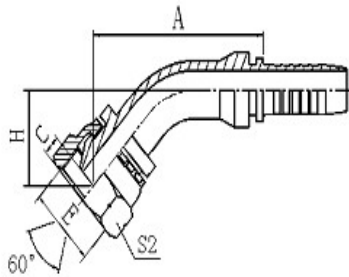

Part. No	Thread E	DN	A	C	H	S2
22641-04-04	G1/4×19	6	42.3	5.5	20.2	19
22641-06-04	G3/8×19	6	43.2	6.3	21	22
22641-06-05	G3/8×19	8	45.3	6.3	22	22
22641-06-06	G3/8×19	10	46.9	6.3	22.6	22
22641-08-06-T	G1/2×14	10	48.1	7.5	23.9	27
22641-08-08	G1/2×14	12	61.1	7.5	26.1	27
22641-10-08	G5/8×14	12	61.4	9.5	26.5	30
22641-10-10	G5/8×14	16	72.6	9.5	27.8	30
22641-12-08-T	G3/4×14	12	61.8	10.9	26.9	32
22641-12-10	G3/4×14	16	73	10.9	28.2	32
22641-12-12	G3/4×14	20	79.2	10.9	31.8	32
22641-16-12-T	G1×11	20	80.8	11.7	33.4	41
22641-16-16	G1×11	25	88.4	11.7	34.2	41
22641-20-16-T	G1. 1/4×11	25	85.3	11	31.1	50
22641-20-20-W	G1. 1/4×11	32	98.8	11	38	50
22641-24-24-W	G1. 1/2×11	40	117	13	45.5	55
22641-32-32-W	G2×11	50	136	16	52.7	70

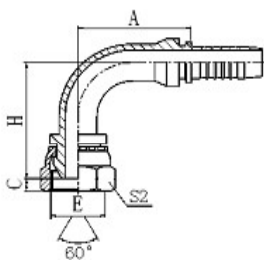

PART NO.	Thread E	DN	A	C	H	S2
22691-04-04	G1/4"X19	6	30	5.5	36.5	19
22691-04-05	G1/4"X19	8	33	5.5	39.5	19
22691-04-06	G1/4"X19	10	30	5.5	36.5	19
22691-06-04	G3/8"X19	6	30	6.3	37.7	22
22691-06-05	G3/8"X19	8	33	6.3	40.7	22
22691-06-06	G3/8"X19	10	35.3	6.3	43	22
22691-08-06T	G1/2"X14	10	35.3	7	43.3	27
22691-08-08	G1/2"X14	12	41	7.5	51	27
22691-08-10	G1/2"X14	16	56.5	7.5	55.5	27
22691-10-08	G5/8"X14	12	41	9.5	51.5	30
22691-10-10	G5/8"X14	16	56.5	9.5	56	30
22691-12-08T	G3/4"X14	12	41	10.9	52.1	32
22691-12-10	G3/4"X14	16	56.5	10.9	56.6	32
22691-12-12	G3/4"X14	20	65.5	10.9	66	32
22691-16-12T	G1"X11	20	65.5	11.7	68.3	41
22691-16-14	G1"X11	22	71.2	11.7	69.3	41
22691-16-16	G1"X11	25	76.7	11.7	73.8	41
22691-20-16T	G1. 1/4"X11	25	78	11	69.5	50
22691-20-20W	G1. 1/4"X11	32	91.5	11	84.3	50
22691-24-24W	G1. 1/2"X11	40	109	13	103	55
22691-32-32W	G2"X11	50	132	16	123	70

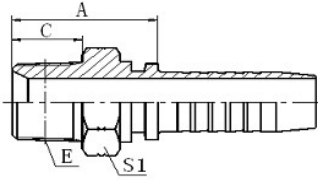

PART NO.	Thread E	DN	A	C	S1
15611-04-04	1/4"X18	6	28	15	17
15611-04-05	1/4"X18	8	28	15	17
15611-04-06	1/4"X18	10	27	15	17
15611-06-04	3/8"X18	6	28	16	19
15611-06-05	3/8"X18	8	28	16	19
15611-06-06	3/8"X18	10	30	16	19
15611-06-08	3/8"X18	12	30.5	16	19
15611-08-06	1/2"X14	10	34.5	19.5	22
15611-08-08	1/2"X14	12	34.5	19.5	22
15611-08-10	1/2"X14	16	36	19.5	22
15611-12-08	3/4"X14	12	37.5	19.5	27
15611-12-10	3/4"X14	16	38	19.5	27
15611-12-12	3/4"X14	20	38.5	19.5	27
15611-12-16	3/4"X14	25	39.5	19.5	32
15611-16-10	1"X11.5	16	45	25.5	36
15611-16-12	1"X11.5	20	45	25.5	36
15611-16-16	1"X11.5	25	44.5	25.5	36
15611-20-16	1.1/4"X11.5	25	49.5	26.5	46
15611-20-20	1.1/4"X11.5	32	49	26.5	46
15611-24-24	1.12"X11.5	40	51	27.5	50
15611-32-32	2"X11.5	50	55	27.5	65

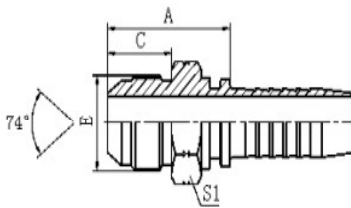

PART NO.	Thread E	DN	A	C	S1
16711-06-04	9/16"X18	6	26.5	14.1	17
16711-06-05	9/16"X18	8	26.5	14.1	17
16711-06-06	9/16"X18	10	26.5	14.1	17
16711-08-06	3/4"X16	10	31.5	16.7	22
16711-08-08	3/4"X16	12	32	16.7	22
16711-10-06	7/8"X14	10	32	19.3	24
16711-10-08	7/8"X14	12	34.3	19.3	24
16711-10-10	7/8"X14	16	35.5	19.3	24
16711-12-08	1.1/16"X12	12	39	21.9	27
16711-12-10	1.1/16"X12	16	40	21.9	27
16711-12-12	1.1/16"X12	20	40	21.9	27
16711-12-16	1.1/16"X12	25	41	21.9	30
16711-14-10	1.3/16"X12	16	41.5	22.6	32
16711-14-12	1.3/16"X12	20	40.6	22.6	32
16711-16-12	1.5/16"X12	20	42.5	23.1	36
16711-16-16	1.5/16"X12	25	43.5	23.1	36
16711-20-16	1.5/8"X12	25	46.5	24.3	46
16711-20-20	1.5/8"X12	32	47.5	24.3	46
16711-24-20	1.7/8"X12	32	53	27.5	50

16711-24-24	1. 7/8"X12	40	53	27.5	50
16711-32-32	2. 1/2"X2	50	62	33.9	65

PART NO.	Thread E	DN	A	C	S1
26711-06-04	9/16"X18	6	15.5	10.5	19
26711-06-05	9/16"X18	8	15.5	10.5	19
26711-06-06	9/16"X18	10	15.5	10.5	19
26711-06-08	9/16"X18	12	16	10.5	19
26711-08-06	3/4"X16	10	17.5	11	24
26711-08-08	3/4"X16	12	18	11	24
26711-08-10	3/4"X16	16	19.5	11	24
26711-10-08	7/8"X14	12	18.5	13	27
26711-10-10	7/8"X14	16	20	13	27
26711-10-12	7/8"X14	20	20	13	27
26711-12-08T	1. 1/16"X12	12	19	15	32
26711-12-10	1. 1/16"X12	16	21.5	15	32
26711-12-12	1. 1/16"X12	20	21.5	15	32
26711-12-16	1. 1/16"X12	25	23	15	32
26711-14-12	1. 3/16"X12	20	21.5	15	36
26711-16-12T	1. 5/16"X12	20	18.5	16	41
26711-16-16	1. 5/16"X12	25	23	16	41
26711-16-20	1. 5/16"X12	32	24	16	41
26711-20-16T	1. 5/8"X12	25	23	17	50
26711-20-20W	1. 5/8"X12	32	26	17	50
26711-24-20W	1. 7/8"X12	32	26.5	20	55
26711-24-24W	1. 7/8"X12	40	26.5	20	55
26711-32-24T	2. 1/2"X2	40	27	23.5	75
26711-32-32W	2. 1/2"X2	50	27	23.5	75

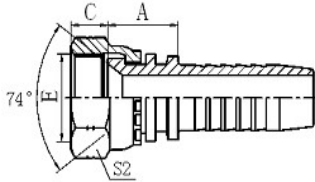

PART NO.	Thread E	DN	A	C	H	S2
26741-04-03	7/16"X20	5	37.6	9	17.2	15
26741-04-04	7/16"X20	6	40.2	9	18.1	15
26741-05-04	1/2"X20	6	40.5	9.5	18.5	17
26741-05-05	1/2"X20	8	42.7	9.5	19.3	17
26741-05-06	1/2"X20	10	44.6	9.5	20.3	17
26741-06-04	9/16"X18	6	40.5	10.5	18.5	19
26741-06-05	9/16"X18	8	42.7	10.5	19.3	19
26741-06-06	9/16"X18	10	44.3	10.5	20	19
26741-06-08	9/16"X18	12	56.8	10.5	21.9	19
26741-08-06	3/4"X16	10	45.7	11	21.4	24
26741-08-08	3/4"X16	12	58.6	11	23.5	24
26741-10-08	7/8"X14	12	58.9	13	24	27
26741-10-10	7/8"X14	16	70.1	13	25.3	27

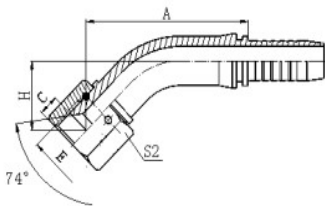

26741-10-12	7/8"X14	20	77	13	28.9	27
26741-12-08	1. 1/16"X12	12	60	15	25	32
26741-12-10	1. 1/16"X12	16	71.2	15	26.4	32
26741-12-12	1. 1/16"X12	20	77.4	15	30	32
26741-12-16	1. 1/16"X12	25	85.3	15	31	32
26741-14-12	1. 3/16"X12	20	77.4	15	30	36
26741-16-12	1. 5/16"X12	20	77.4	16	30	41
26741-16-16	1. 5/16"X12	25	85.7	16	31.5	41
26741-16-20	1. 5/16"X12	32	96.3	16	35.5	41
26741-20-20W	1. 5/8"X12	32	96.6	17	35.9	50
26741-24-20W	1. 7/8"X12	32	101	20	40.1	55
26741-24-24W	1. 7/8"X12	40	115	20	44.4	55
26741-32-32W	2. 1/2"X2	50	136	23.5	51.6	75

PART NO.	Thread E	DN	A	C	H	S2
26791-04-03	7/16"X20	5	26.5	9	30.5	15
26791-04-04	7/16"X20	6	30	9	33.5	15
26791-05-04	1/2"X20	6	30	9.5	34	17
26791-05-05	1/2"X20	8	33	9.5	37	17
26791-05-06	1/2"X20	10	35.3	9.5	39.3	17
26791-06-04	9/16"X18	6	30	10.5	34	19
26791-06-05	9/16"X18	8	33	10.5	37	19
26791-06-06	9/16"X18	10	35.3	10.5	39.3	19
26791-06-08	9/16"X18	12	41	10.5	45.5	19
26791-08-06	3/4"X16	10	35.3	11	41.3	24
26791-08-08	3/4"X16	12	41	11	47	24
26791-08-10	3/4"X16	16	56.5	11	51.5	24
26791-10-08	7/8"X14	12	41	13	48	27
26791-10-10	7/8"X14	16	56.5	13	52.5	27
26791-10-12	7/8"X14	20	67	13	64	27
26791-12-08	1. 1/16"X12	12	41	15	49.5	32
26791-12-10	1. 1/16"X12	16	56.5	15	54	32
26791-12-12	1. 1/16"X12	20	65.5	15	63.5	32
26791-12-16	1. 1/16"X12	25	76.7	15	70	32
26791-14-12	1. 3/16"X12	20	65.5	15	63.5	36
26791-16-12	1. 5/16"X12	20	65.5	16	63.5	41
26791-16-16	1. 5/16"X12	25	76.7	16	70	41
26791-16-20	1. 5/16"X12	32	91.5	16	81	41
26791-20-20W	1. 5/8"X12	32	91.5	17	80.5	50
26791-24-20W	1. 7/8"X12	32	91.5	20	79.5	55
26791-24-24W	1. 7/8"X12	40	109	20	94	55
26791-32-32W	2. 1/2"X2	50	133	23.5	122	75

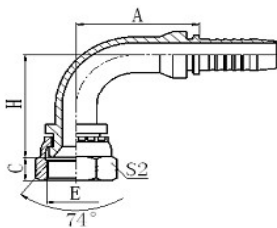

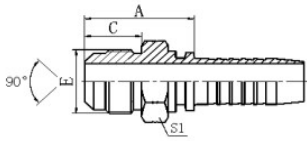

PART NO.	Thread E	DN	A	C	S1
17811-04-04	7/16"X20	6	25.5	12.7	12
17811-05-05	1/2"X20	8	27	14.2	14
17811-06-06	5/8"X18	10	28.5	15.7	17
17811-08-08	3/4"X16	12	34	19	22
17811-10-10	7/8"X14	16	38.5	22.4	24
17811-12-12	1/16"X14	20	43.5	25.4	30

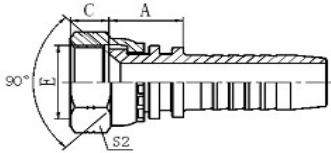

PART NO.	Thread E	DN	A	C	S1
27811-04-03	7/16"X20	5	14	9	15
27811-04-04	7/16"X20	6	15	9	15
27811-05-05	1/2"X20	8	15.5	9.5	17
27811-06-04	5/8"X18	6	17	11.3	22
27811-06-05	5/8"X18	8	17	11.3	22
27811-06-06	5/8"X18	10	17	11.3	22
27811-08-08	3/4"X16	12	18	11	24
27811-10-08	7/8"X14	12	18.5	13	27
27811-10-10	7/8"X14	16	20	13	27
27811-12-12	1/16"X14	20	21.5	14.3	32

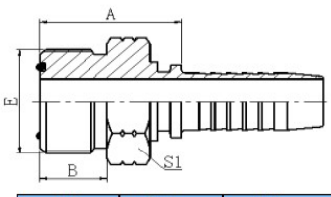

PART NO.	Thread E	DN	A	C	S1	D RING
14211-04-04	9/16"X18	6	22.3	9.8	17	0011
14211-06-04	11/16"X16	6	24	11.2	19	0012
14211-06-06	11/16"X16	10	24	11.2	19	0012
14211-08-06	13/16"X16	10	27.5	12.8	22	0014
14211-08-08	13/16"X16	12	28.5	12.8	22	0014
14211-08-10	13/16"X16	16	28.5	12.8	22	0014
14211-10-08	1"X14	12	32.5	15.5	27	0016
14211-10-10	1"X14	16	34	15.5	27	0016
14211-12-08	1.3/16"X12	12	35.5	17	32	0018
14211-12-10	1.3/16"X12	16	36.5	17	32	0018
14211-12-12	1.3/16"X12	20	36.5	17	32	0018
14211-16-12	1.7/16"X12	20	37	17.5	38	0021
14211-16-16	1.7/16"X12	25	38.5	17.5	38	0021
14211-20-20	1.11/16"X12	32	41.5	17.5	46	0025
14211-24-24	2"X12	40	43.5	17.5	55	0029

PART NO.	Thread E	DN	A	C	S1
24211-04-04	9/16"X18	6	22.5	8.5	19

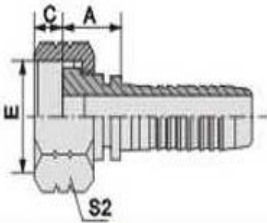

24211-04-05	9/16"X18	8	22.5	8.5	19
24211-04-06	9/16"X18	10	22.5	8.5	19
24211-06-04T	11/16"x16	6	23.5	10	22
24211-06-05T	11/16"x16	8	23.5	10	22
24211-06-06	11/16"x16	10	23.5	10	22
24211-06-08	11/16"x16	12	26	10	22
24211-08-05T	13/16"x16	8	25	11	27
24211-08-06T	13/16"x16	10	25	11	27
24211-08-08	13/16"x16	12	28	11	27
24211-08-10	13/16"x16	16	29	11	27
24211-10-08T	1"x14	12	29.5	13.5	30
24211-10-10	1"x14	16	33.5	13.5	30
24211-10-12	1"x14	20	33.5	13.5	30
24211-12-08T	1.3/16"x12	12	30.5	15	36
24211-12-10T	1.3/16"x12	16	31.5	15	36
24211-12-12	1.3/16"x12	20	35	15	36
24211-12-16	1.3/16"x12	25	36	15	36
24211-16-12T	1.7/16"x12	20	35	14.8	41
24211-16-14T	1.7/16"x12	22	34	14.8	41
24211-16-16T	1.7/16"x12	25	35	14.8	41
24211-16-20	1.7/16"x12	32	39.5	14.8	41
24211-20-16T	1.11/16"x12	25	35	15	50
24211-20-20W	1.11/16"x12	32	39.5	15	50
24211-20-24w	1.11/16"x12	40	39.5	15	50
24211-24-20T	2"x12	32	36	14.8	60
24211-24-24T	2"x12	40	36	14.8	60

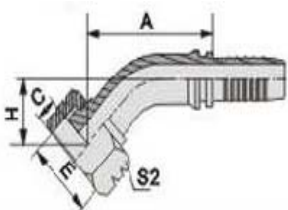

PART NO.	Thread E	DN	A	H	C	S2
24241-04-04	9/16"X18	6	45.5	23.4	8.5	19
24241-04-05	9/16"X18	8	46.7	24.3	8.5	19
24241-04-06	9/16"X18	10	49.2	24.9	8.5	19
24241-06-04T	11/16"x16	6	39.5	17.4	10	22
24241-06-05T	11/16"x16	8	42.3	19	10	22
24241-06-06	11/16"x16	10	51.7	27.4	10	22
24241-06-08	11/16"x16	12	63.9	29	10	22
24241-08-06T	13/16"x16	10	44.6	20.3	11	27
24241-08-08	13/16"x16	12	65.3	30.4	11	27
24241-08-10	13/16"x16	16	76.5	31.7	11	27
24241-10-08T	1"x14	12	58.2	23.3	13.5	30
24241-10-10	1"x14	16	79.7	34.9	13.5	30
24241-10-12	1"x14	20	86.5	38.4	13.5	30
24241-12-08T	1.3/16"x12	12	58.2	23.3	15	36
24241-12-10	1.3/16"x12	16	69.4	24.6	15	36

24241-12-12	1. 3/16"x12	20	87.6	39.5	15	36
24241-12-16	1. 3/16"x12	25	95.3	41	15	36
24241-16-12T	1. 7/16"x12	20	74	29.6	14.8	41
24241-16-14T	1. 7/16"x12	22	78.7	28.5	14.8	41
24241-16-16T	1. 7/16"x12	25	84.1	29.7	14.8	41
24241-16-20	1. 7/16"x12	32	104	46.1	14.8	41
24241-20-16T	1. 11/16"x12	25	80.9	32.7	15	50
24241-20-20W	1. 11/16"x12	32	111	49	15	50
24241-20-24W	1. 11/16"x12	40	124	52.9	15	50
24241-24-20T	2"x12	32	94.5	33.8	14.8	60
24241-24-24T	2"x12	40	109	37.7	14.8	60

PART NO.	Thread E	DN	A	C	H	S2
24291-04-04	9/16"x18	6	30	41	8.5	19
24291-04-05	9/16"x18	8	33	44	8.5	19
24291-04-06	9/16"x18	10	35.5	46.3	8.5	19
24291-06-05T	11/16"x16	8	33	37.5	10	22
24291-06-06	11/16"x16	10	35.5	49.8	10	22
24291-06-08	11/16"x16	12	41	55	10	22
24291-08-06T	11/16"x16	10	35.3	39.8	11	27
24291-08-08	11/16"x16	12	41	57	11	27
24291-08-10	11/16"x16	16	56.5	61.5	11	27
24291-10-08T	1"x14	12	41	46	13.5	30
24291-10-10	1"x14	16	56.5	66	13.5	30
24291-10-12	1"x14	20	65.5	75.5	13.5	30
24291-12-10T	1. 3/16"x12	16	56.5	51.5	15	36
24291-12-12	1. 3/16"x12	20	65.5	77	15	36
24291-12-16	1. 3/16"x12	25	75.7	83.5	15	36
24291-16-12T	1. 7/16"x12	20	65.5	63	14.8	41
24291-16-14T	1. 7/16"x12	22	71.2	63	14.8	41
24291-16-16T	1. 7/16"x12	25	76.9	67.5	14.8	41
24291-16-20	1. 7/16"x12	32	91.5	96	14.8	41
24291-20-16T	1. 11/16"x12	25	76.7	67.5	15	50
24291-20-20W	1. 11/16"x12	32	93	100	15	50
24291-20-24W	1. 11/16"x12	40	109	114	15	50
24291-24-20T	2"x12	32	91.5	78.5	14.8	60
24291-24-24T	2"x12	40	109	92	14.8	60

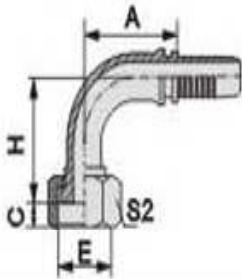

PART NO.	Flange Size	DN	A	C	D	L
87311-08-08	1/2"	12	46	30.2	24	6.73
87311-12-08	3/4"	12	47	38.1	31.7	6.73
87311-12-10	3/4"	16	48	38.1	31.7	6.73

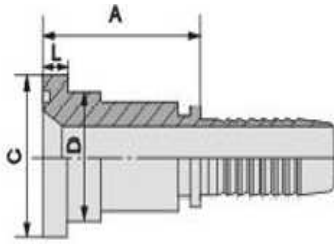

87311-12-12	3/4"	20	48	38.1	31.7	6.73
87311-12-16	3/4"	25	49	38.1	31.7	6.73
87311-16-12	1"	20	51	44.4	38	8
87311-16-16	1"	25	52	44.4	38	8
87311-16-20	1"	32	53	44.4	38	8
87311-20-16	1.1/4"	25	57	50.8	43	8
87311-20-20	1.1/4"	32	58	50.8	43	8
87311-24-20	1.1/2"	32	68	60.3	50	8
87311-24-24	1.1/2"	40	68	60.3	50	8
87311-32-24	2"	40	70	71.4	62	9.53
87311-32-32	2"	50	70	71.4	62	9.53

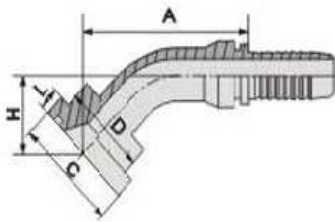

PART NO.	Flange Size	DN	A	C	D	H	L
87341-08-08	1/2"	12	58.2	30.2	24	23.3	6.73
87341-12-08	3/4"	12	58.9	38.1	31.7	24	6.73
87341-12-10	3/4"	16	70.1	38.1	31.7	25.3	6.73
87341-12-12	3/4"	20	77	38.1	31.7	28.9	6.73
87341-16-12	1"	20	77	44.4	38	28.9	8
87341-16-16	1"	25	85.2	44.4	38	29.7	8
87341-16-20	1"	32	94.5	44.4	38	33.8	8
87341-20-16	1.1/4"	25	85.2	50.8	43	29.7	8
87341-20-20	1.1/4"	32	94.5	50.8	43	33.8	8
87341-24-20	1.1/2"	32	95.9	60.3	50	35.2	8
87341-24-24	1.1/2"	40	109	60.3	50	39.1	8
87341-32-24	2"	40	110	71.4	62	39.1	9.53
87341-32-32	2"	50	129	71.4	62	46.3	9.3

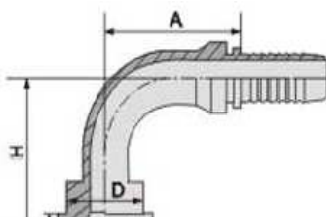

PART NO.	Flange Size	DN	A	C	D	H	L
87391-08-08	1/2"	12	41	30.2	24	47	6.73
87391-12-08	3/4"	12	41	38.1	31.7	48	6.73
87391-12-10	3/4"	116	56.5	38.1	31.7	52.5	6.73
87391-12-12	3/4"	20	66.2	38.1	31.7	62	6.73
87391-12-12 (H1	3/4"	20	65.5	38.1	31.7	100	6.73
87391-12-12 (H1	3/4"	20	65.5	38.1	31.7	127	6.73
87391-12-12 (H1	3/4"	20	65.5	38.1	31.7	150	6.73
87391-12-16	3/4"	25	76.7	38.1	31.7	67.5	6.73
87391-16-12	1"	20	66.2	44.4	38	62	8
87391-16-16	1"	25	78	44.4	38	67.5	8
87391-16-16 (H1	1"	25	76.7	44.4	38	100	8
87391-16-16 (H1	1"	25	76.7	44.4	38	127	8

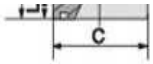

87391-16-16 (H1)	1"	25	76.7	44.4	38	150	8
87391-16-20	1"	32	91.5	44.4	38	78.5	8
87391-20-16	1. 1/4"	25	78	50.8	43	67.5	8
87391-20-20	1. 1/4"	32	91.5	50.8	43	78.5	8
87391-20-20 (H1)	1. 1/4"	32	91.5	50.8	43	100	8
87391-20-20 (H1)	1. 1/4"	32	91.5	50.8	43	127	8
87391-20-20 (H1)	1. 1/4"	32	91.5	50.8	43	150	8
87391-20-24	1. 1/4"	40	109	50.8	43	78.5	8
87391-24-20	1. 1/2"	32	91.5	60.3	50	80.5	8
87391-24-24	1. 1/2"	40	109	60.3	50	94	8
87391-24-24 (H1)	1. 1/2"	40	109	60.3	50	127	8
87391-32-24	2"	40	109	71.4	62	94	9.53
87391-32-32	2"	50	132	71.4	62	114.3	9.53
87391-40-32	2. 1/2"	50	132	84.1	74.4	114.3	9.53

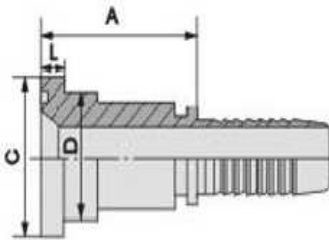

PART NO.	Flange Size	DN	A	C	D	L
87611-08-08	1/2"	12	47	31.7	24	7.75
87611-12-10	3/4"	16	51	41.3	32	8.76
87611-12-12	3/4"	20	51	41.3	32	8.76
87611-16-12	1"	20	56	47.6	38	9.53
87611-16-16	1"	25	57	47.6	38	9.53
87611-16-20	1"	32	61	47.6	38	9.53
87611-20-16	1. 1/4"	25	65	54	44	10.29
87611-20-20	1. 1/4"	32	66	54	44	10.29
87611-24-20	1. 1/2"	32	75	63.5	51	12.57
87611-24-24	1. 1/2"	40	75	63.5	51	12.57
87611-32-24	2"	40	85	79.4	67	12.57
87611-32-32	2"	50	85	79.4	67	12.57

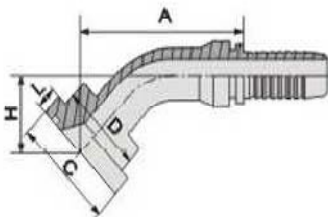

PART NO.	Flange Size	DN	A	C	D	L
87641-08-08	1/2"	12	58.9	24	24	7.75
87641-08-12	1/2"	20	74.9	24	27.5	7.75
87641-12-10	3/4"	16	72.5	32	28.2	8.76
87641-12-12	3/4"	20	79.2	32	31.8	8.76
87641-16-16	1"	25	90.2	38	34.7	9.53
87641-20-20	1. 1/4"	32	104	44	41.5	10.29
87641-24-20	1. 1/2"	32	106	51	45.1	12.57
87641-24-24	1. 1/2"	40	116	51	45.5	12.57
87641-32-24	2"	40	125	67	54.7	12.57
87641-32-32	2"	50	136	67	52.7	12.57

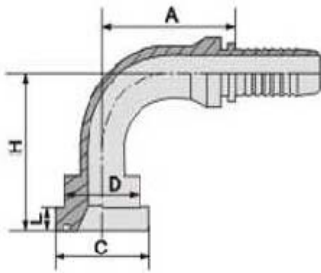

PART NO.	Flange Size	DN	A	C	D	H	L
87691-08-08	1/2"	12	41	31.7	24	48	7.75
87691-12-10	3/4"	16	56.5	41.3	32	56.5	8.76
87691-12-12	3/4"	20	66.2	41.3	32	66	8.76
87691-16-12	1"	20	66.2	47.6	38	69	9.53
87691-16-16	1"	25	78	47.6	38	74.5	9.53
87691-16-20	1"	32	91.5	47.6	38	85.5	9.53
87691-20-16	1. 1/4"	25	78	54	44	78.5	10.29
87691-20-20	1. 1/4"	32	91.5	54	44	89.5	10.29
87691-24-20	1. 1/2"	32	91.5	63.5	51	94.5	12.57
87691-24-24	1. 1/2"	40	109	63.5	51	108	12.57
87691-32-24	2"	40	109	79.4	67	116	12.57
87691-32-32	2"	50	132	79.4	67	136.3	12.57

PART NO.	Thread E	DN	A	d	D	H
70011-12-04	M12. X1.5	6	20.5	12.1	20	12
70011-12-05	M12. X1.5	8	20.5	12.1	20	12
70011-12-06	M12. X1.5	10	20.5	12.1	20	12
70011-14-04	M14X1.5	6	21	14.1	24	14
70011-14-05	M14X1.5	8	21	14.1	24	14
70011-14-06	M14X1.5	10	21	14.1	24	14
70011-16-04	M16X1.5	6	20.5	16.1	28	16
70011-16-05	M16X1.5	8	20.5	16.1	28	16
70011-16-06	M16X1.5	10	20.5	16.1	28	16
70011-18-04	M18X1.5	6	23	18.1	32	20
70011-18-05	M18X1.5	8	24	18.1	32	20
70011-18-06	M18X1.5	10	24	18.1	32	20
70011-18-08	M18X1.5	12	24.5	18.1	32	20
70011-22-06	M22X1.5	10	28.1	22.1	39	25
70011-22-08	M22X1.5	12	28.5	22.1	39	25
70011-22-10	M22X1.5	16	28	22.1	39	25
70011-26-12	M26X1.5	20	32.5	22.1	46	30
70011-30-16	M30X1.5	25	37	30.1	54	36
70011-30-20	M30X1.5	32	40	30.1	54	36

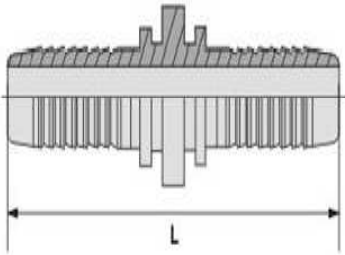

PART NO.	DN	L
90012-04	6	83
90012-05	8	87
90012-06	10	87
90012-08	12	91
90012-10	16	97
90012-12	20	110
90012-16	25	134
90012-20	32	153
90012-24	40	172
90012-32	50	178